

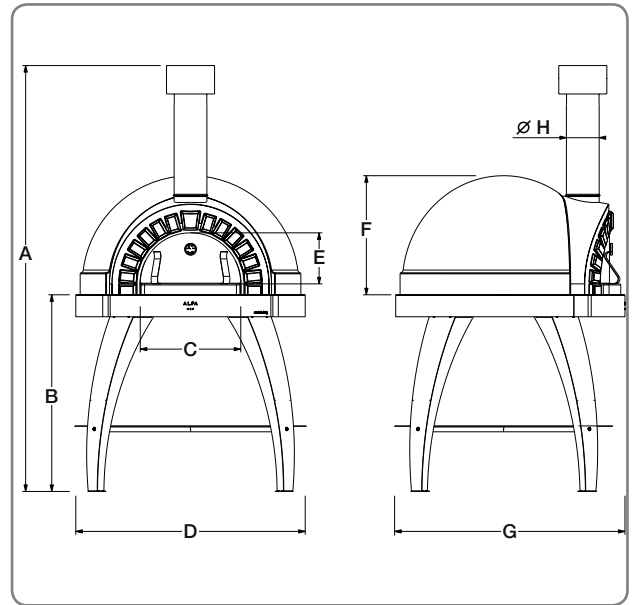

MISURE / DIMENSIONS



CARATTERISTICHE TECNICHE / TECHNICAL DETAILS

Peso / Weight	298 kg / 656 lbs		
Area piano forno / Oven floor area	Diam. piano forno / Oven floor diam.	0,38 m ² / 4,09 ft ²	70 cm / 27,5 in
Minuti per scaldare / Heating time	45		
N° pizze alla volta / Pizza capacity	2		
Infornata di pane / Bread capacity	4 kg / 8,8 lbs		
Consumo medio / Average fuel consumption	4 kg/h / 8,8 lbs/h		
Temperatura massima / Max oven temperature	400 °C 752 °F		
Combustibile consigliato / Recommended fuel	Ciocchi diam. max. 10 cm, potature / Max. 3,9 in diam. logs, trimmings		

MISURE / DIMENSIONS

A	Altezza totale / Total height	197,3 cm / 77,7 in
B	Altezza base / Base height	90 cm / 35,4 in
C	Larghezza bocca / Oven mouth width	46 cm / 18,1 in
D	Larghezza totale / Total width	105 cm / 41,3 in
E	Altezza bocca / Oven mouth height	23,3 cm / 9,2 in
F	Altezza forno / Oven width	54,5 cm / 21,5 in
G	Lunghezza totale / Total length	105,4 cm / 41,5 in
H	Diametro canna / Flue diameter	15 cm / 5,9 in

MONTAGGIO e componenti / ASSEMBLY and parts list

	Cod.	N°	Desc.
a	SCUP-01-025-XX	1	Comignolo antivento
b	TIN150_500	1	Canna fumaria
c	XFCCUPA	1	Cupola esterna
d	XFCCUP	1	Cupola interna
e	XFPCUPA	1	Piano forno
f	SCUP-01-020-XX	1	Sportello
g	YTE5040	1	Pirometro D.50 L.40 mm
h	SCUP-01-011-XX	1	Ripiano inferiore
i	SCUP-01-002-XX	1	Base

